

# Dryer

## DE-30, 50, 75 Parts Manual

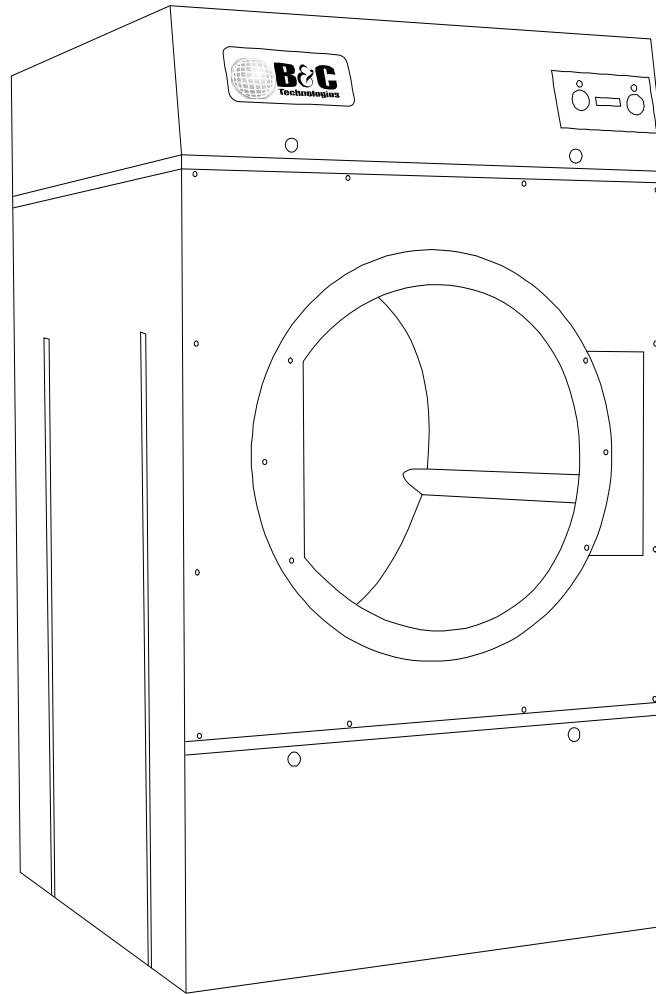

**B&C Technologies**  
Panama City, FL  
(850) 249-2222  
(850) 249-2226 FAX  
[www.bandctech.com](http://www.bandctech.com)

**Accurate Technologies**  
Samutprakarn, Thailand  
+ 66 (0) 2740-5511  
+ 66 (0) 2740-5522 FAX  
[www.accuratethai.com](http://www.accuratethai.com)

Revision 2.2  
27-SEP-2010





Item	Part No.			Qty.	Description
	DE 30	DE 50	DE 75		
1	A2-S030-001	A2-SDE1-061	A2-SDE1-061	1	Front panel, Top (Micro Model)
	A2-S030-025	A2-SDE1-062	A2-SDE1-062	1	Front panel, Top (Timer Model)
2	A2-S030-002	A2-SDE1-063	A2-SDE1-063	1	Front panel, middle
3	A2-S030-003	A2-SDE1-064	A2-SDE1-064	1	Front panel, lower
4	A2-S030-007	A2-S050-007	A2-S075-007	1	Left panel assembly
5	A2-S030-008	A2-S050-008	A2-S075-008	1	Right panel assembly
6	A2-S030-038	A2-SDE1-067	A2-SDE1-067	1	Door ring include door glass
7	A2-S030-006	A2-SDE1-058	A2-SDE1-058	1	Hinge, Door mounting (Hinge and hinge shaft)
8	A2-S030-004	A2-SDE1-059	A2-SDE1-059	1	Door handle
9	A0-A013-002	A0-A013-002	A0-A013-002	2	Lock, C-174
10	A0-A038-015	A0-A038-001	A0-A038-001	1	Guard, Bumper

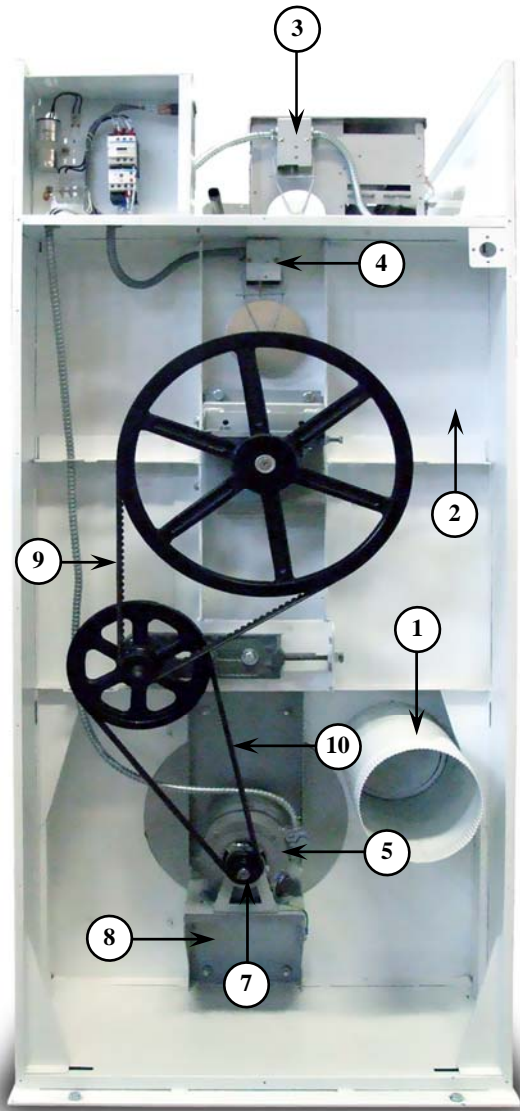

Model : 30, 50 lb.

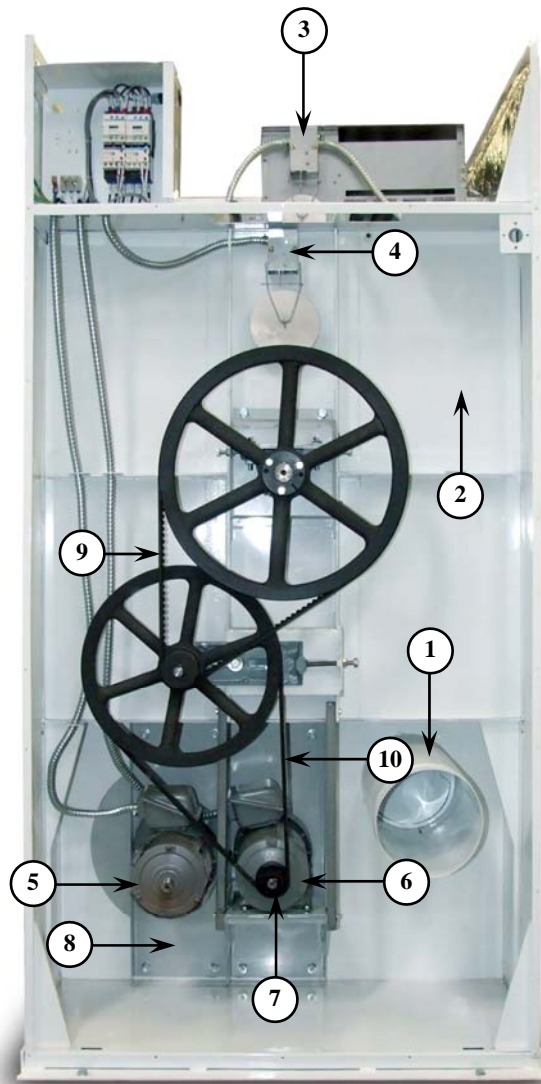

Model : 75 lb.

Item	Part No.			Qty.	Description
	DE 30	DE 50	DE 75		
1	A2-S030-009	A2-S050-009	A2-S075-009	1	Exhaust duct outlet
2	A2-S030-010	A2-S050-010	A2-S075-010	1	Rear panel assembly
3	A0-E014-010	A0-E014-010	A0-E014-010	1	Micro switch
	A2-SDE1-028	A2-SDE1-028	A2-SDE1-028	1	Cabinet sail switch complete shell (Gas)
4	A0-E014-010	A0-E014-010	A0-E014-010	1	Micro switch
	A2-SDE1-027	A2-SDE1-027	A2-SDE1-027	1	Cabinet sail switch complete shell
5	A0-E008-091	A0-E008-091	A0-E008-091	1	Basket and blower Motor (1Ph)
6	-	-	A0-E008-092	1	Basket motor (1Ph)
7	A0-M008-113	A0-M008-086	A0-M008-086	1	Motor pulley (For 50 Hz., 1Ph)
	A0-M008-093	A0-M008-027	A0-M008-027	1	Motor pulley (For 60 Hz., 1Ph)
8	A2-S030-022	A2-S050-022	A2-S075-022	1	Support blower motor
9	A0-A002-214	A0-A002-214	A0-A002-214	1	Basket V-Belt (1Ph)
10	A0-A002-220	A0-A002-003	A0-A002-217	1	Motor V-Belt (1Ph.)

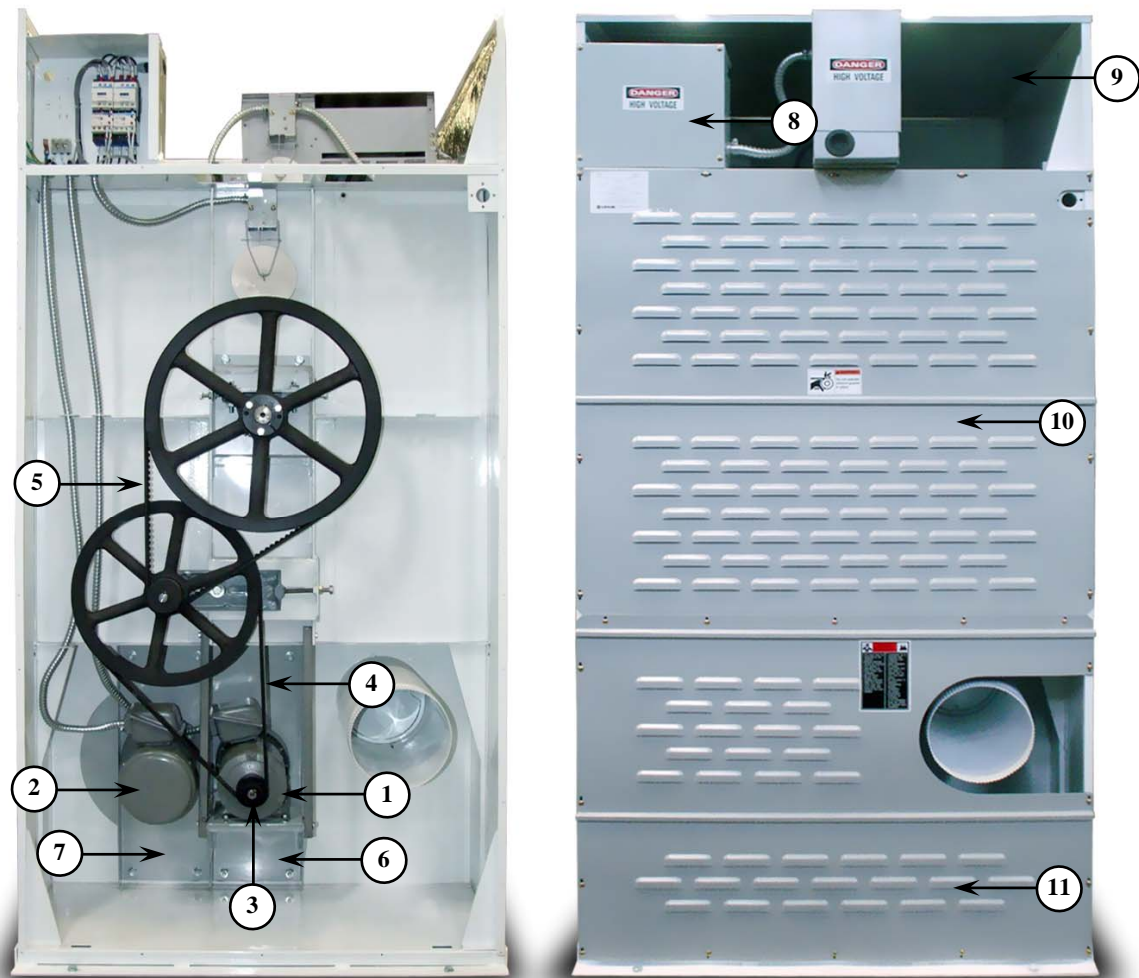

Item	Part No.			Qty.	Description
	DE 30	DE 50	DE 75		
1	A0-E008-819	A0-E008-805	A0-E008-805	1	Basket motor "Mitsubishi"
	-	A0-E008-873	A0-E008-873	1	Basket motor "Hitachi"
	-	A0-E008-081	A0-E008-081	1	Basket motor "Siemens"
2	A0-E008-820	A0-E008-840	A0-E008-840	1	Blower motor "Mitsubishi"
	-	A0-E008-872	A0-E008-872	1	Blower motor "Hitachi"
	-	A0-E008-082	A0-E008-082	1	Blower motor "Siemens"
3	A0-M008-106	A0-M008-086	A0-M008-086	1	Motor pulley (For 50 Hz., 3Ph)
	A0-M008-114	A0-M008-027	A0-M008-027	1	Motor pulley (For 60 Hz., 3Ph)
4	A0-A002-216	A0-A002-217	A0-A002-217	1	Motor V-Belt (3Ph.)
5	A0-A002-214	A0-A002-214	A0-A002-214	1	Basket V Belt (3Ph)
6	A2-S030-028	A2-SDE1-022	A2-SDE1-022	1	Basket motor mounting plate, for 3Ph
7	A2-S030-029	A2-SDE1-022	A2-SDE1-022	1	Blower motor mounting plate, for 3Ph
8	A2-S030-011	A2-S050-011	A2-S075-011	1	Electrical box
9	A2-S030-013	A2-S050-013	A2-S075-013	1	Cover, Top
10	A2-S030-026-01	A2-SDE1-041-01	A2-SDE1-041-01	1	Back guard upper
11	A2-S030-026-02	A2-SDE1-041-02	A2-SDE1-041-02	1	Back guard lower

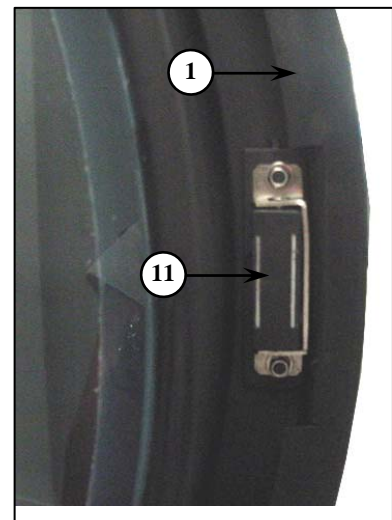
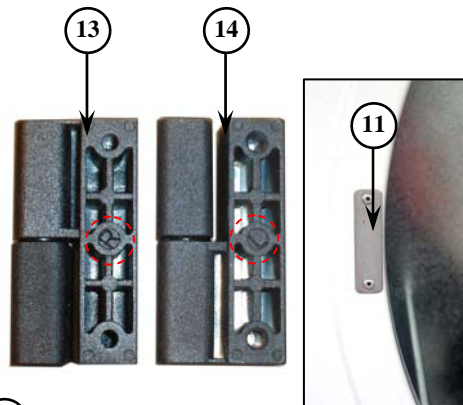
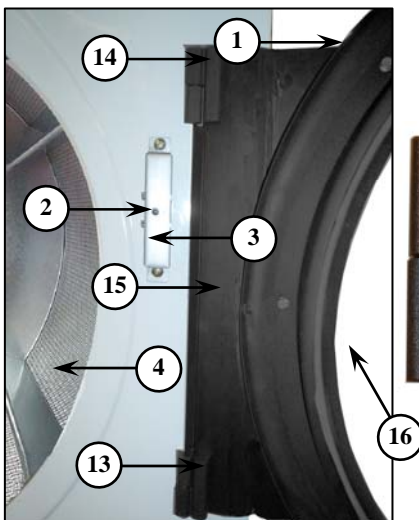
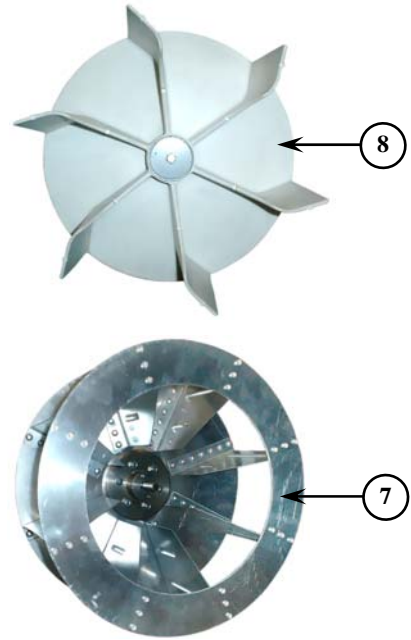
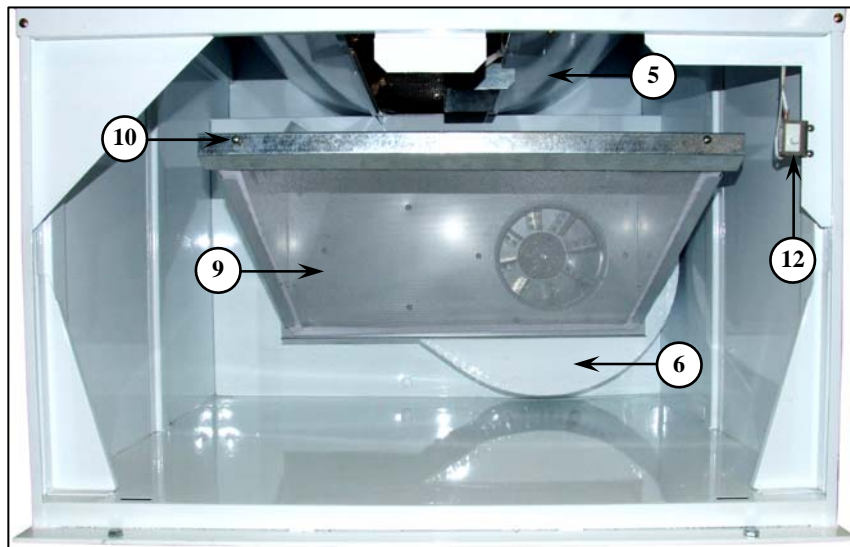

Item	Part No.			Qty.	Description
	DE 30	DE 50	DE 75		
1	A0-A001-048-01	A0-A001-048-02	A0-A001-048-02	1	Door gasket
2	A0-E015-017	A0-E015-017	A0-E015-017	1	Door switch
3	A2-SDE1-046	A2-SDE1-046	A2-SDE1-046	1	Door switch box
4	A2-S030-014	A2-S050-014	A2-S075-014	1	Basket galvanized
	A2-S030-040	A2-S050-040	A2-S075-040	1	Basket stainless
5	A2-S030-018	A2-S050-018	A2-S075-018	1	Assembly, shell
6	A2-S030-019	A2-S050-019	A2-S075-019	1	Fan side plate
7	A0-M003-001	A0-M003-002	A0-M003-003	1	Wheel suction fan (3 Ph.) Metal
	A0-M003-015	A0-M003-016	A0-M003-017	1	Wheel suction fan (1 Ph.) Metal
	A0-M003-021	A0-M003-022	A0-M003-022	1	Wheel suction fan (3 Ph.) Plastic
8	A0-M003-020	A0-M003-020	A0-M003-020	1	Wheel suction fan (1 Ph.) Plastic
	A0-A043-001	A0-A043-002	A0-A043-003	1	Lint drawer filter
10	A0-A060-005	A0-A060-005	A0-A060-005	15	Screw
11	A0-A036-004	A0-A036-004	A0-A036-004	1	Magnet catch
12	A0-E015-011	A0-E015-011	A0-E015-011	1	Switch, limit momentary
13	A2-S030-041	A0-A029-006	A0-A029-006	1	Bracket hinge, Lower (R)
14	A2-S030-042	A0-A029-007	A0-A029-007	1	Bracket hinge, Upper (L)
15	A2-S030-006	A2-SDE1-070	A2-SDE1-070	1	Hinge, Door mounting
16	A0-A003-008	A0-A003-009	A0-A003-009	1	Door glass

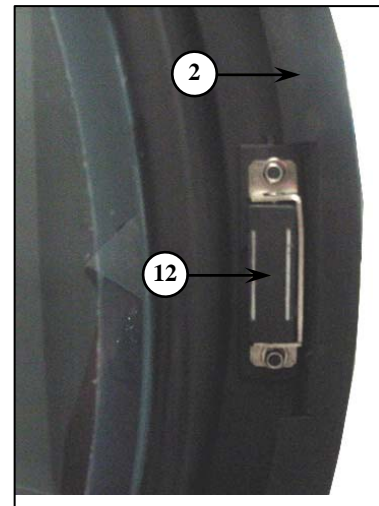
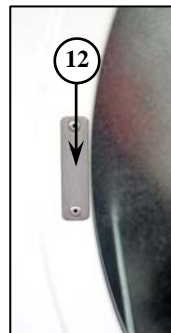
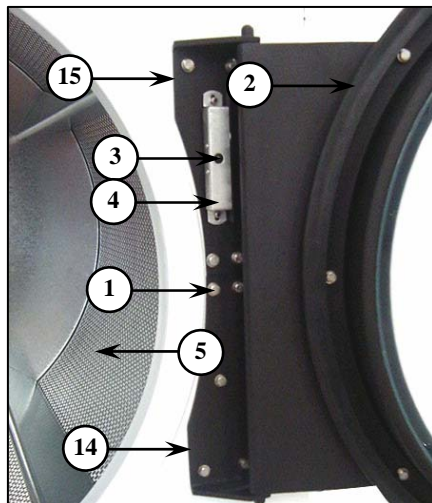
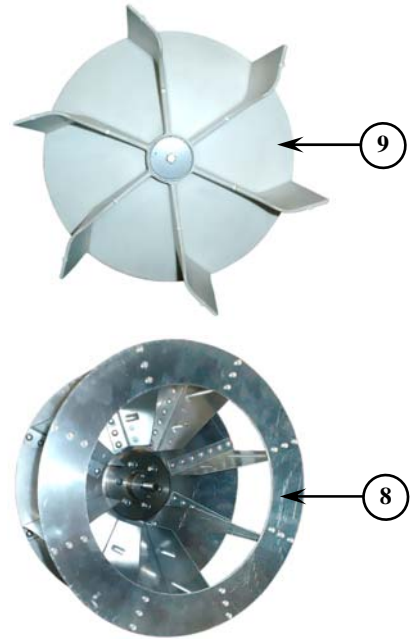
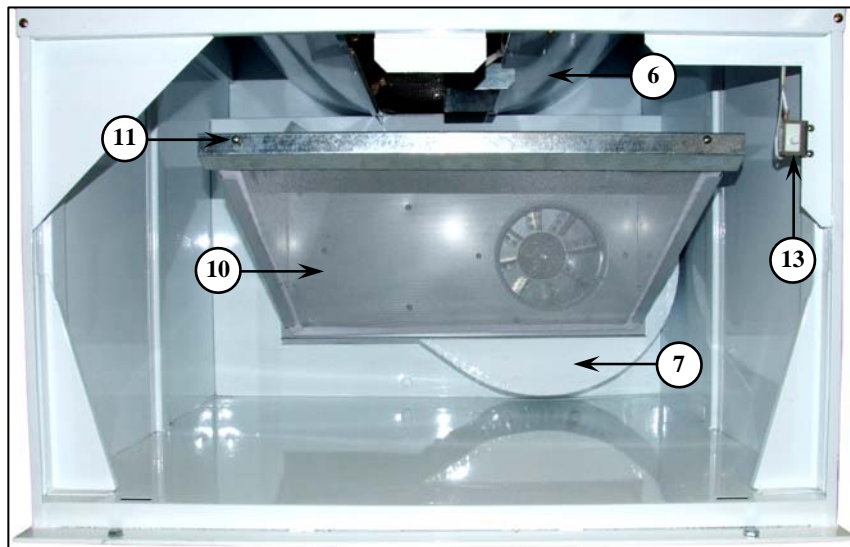

Item	Part No.			Qty.	Description
	DE 30	DE 50	DE 75		
1	A0-A078-012	A0-A078-012	A0-A078-012	9	Nut & Screw
2	A0-A001-048-01	A0-A001-048-02	A0-A001-048-02	1	Door gasket
3	A0-E015-017	A0-E015-017	A0-E015-017	1	Door switch
4	A2-SDE1-046	A2-SDE1-046	A2-SDE1-046	1	Door switch box
5	A2-S030-014	A2-S050-014	A2-S075-014	1	Basket galvanized
6	A2-S030-018	A2-S050-018	A2-S075-018	1	Assembly, shell
7	A2-S030-019	A2-S050-019	A2-S075-019	1	Fan side plate
8	A0-M003-001	A0-M003-002	A0-M003-003	1	Wheel suction fan (3 Ph.) Metal
	A0-M003-015	A0-M003-016	A0-M003-017	1	Wheel suction fan (1 Ph.) Metal
9	A0-M003-021	A0-M003-022	A0-M003-022	1	Wheel suction fan (3 Ph.) Plastic
	A0-M003-020	A0-M003-020	A0-M003-020	1	Wheel suction fan (1 Ph.) Plastic
10	A0-A043-001	A0-A043-002	A0-A043-003	1	Lint drawer filter
11	A0-A060-005	A0-A060-005	A0-A060-005	15	Screw
12	A0-A036-004	A0-A036-004	A0-A036-004	1	Magnet catch
13	A0-E015-011	A0-E015-011	A0-E015-011	1	Switch, limit momentary
14	A2-S030-041	A2-SDE1-033	A2-SDE1-033	1	Bracket hinge, Lower
15	A2-S030-042	A2-SDE1-034	A2-SDE1-034	1	Bracket hinge, Upper

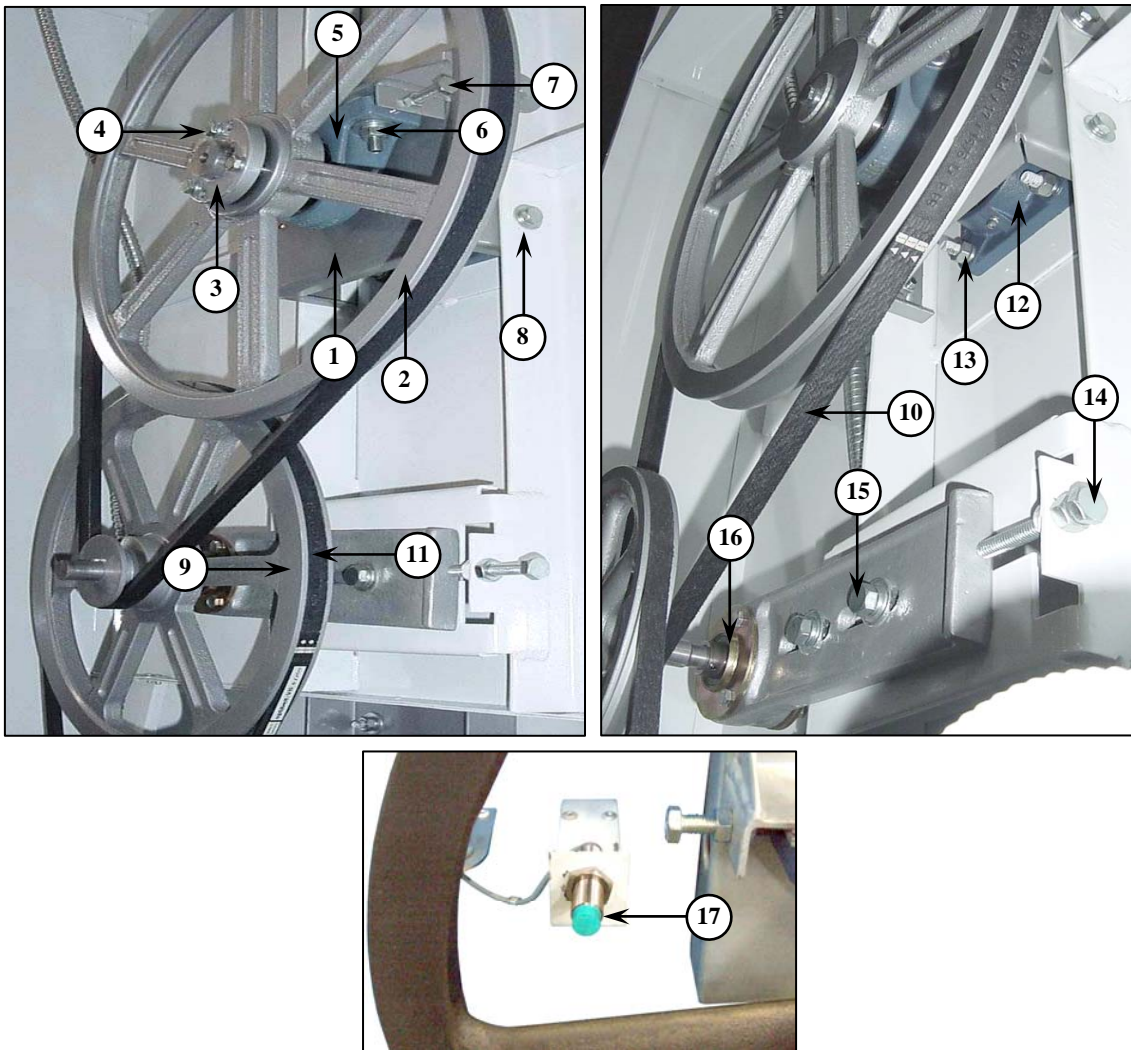

Option : Rotation Sensor

Item	Part No.			Qty.	Description
	DE 30	DE 50	DE 75		
1	A2-S030-021	A2-S050-021	A2-S075-021	1	Support bearing
2	A0-M008-025	A0-M008-025	A0-M008-025	1	Basket pulley
3	A0-M009-033	A0-M009-033	A0-M009-033	1	Basket pulley bushing
4	A0-A079-028	A0-A079-028	A0-A079-028	3	Hexagon bolt
5	A0-A004-039	A0-A004-039	A0-A004-039	1	Bearing pillow block unit
6	A0-A079-026	A0-A079-026	A0-A079-026	2	Hexagon bolt
7	A0-A079-026	A0-A079-026	A0-A079-026	2	Hexagon bolt
8	A0-A079-032	A0-A079-032	A0-A079-032	4	Hexagon bolt
9	A0-M008-026	A0-M008-028	A0-M008-028	1	Idler pulley
10	A0-A002-214	A0-A002-214	A0-A002-214	1	Basket V-Belt (1-3Ph)
11	A0-A002-220	A0-A002-003	A0-A002-217	1	Motor V-Belt (1Ph.)
	A0-A002-216	A0-A002-217	A0-A002-217	1	Motor V-Belt (3Ph.)
12	A0-A004-088	A0-A004-085	A0-A004-085	1	Bearing flanged unit
13	A0-A079-024	A0-A079-024	A0-A079-024	4	Hexagon bolt
14	A0-A076-009	A0-A076-009	A0-A076-009	1	Hexagon bolt
15	A0-A076-010	A0-A076-010	A0-A076-010	2	Hexagon bolt
16	A0-A004-034	A0-A004-034	A0-A004-034	2	Bearing
17	A0-E023-009	A0-E023-009	A0-E023-009	1	Rotation sensor (Proximity sensor)



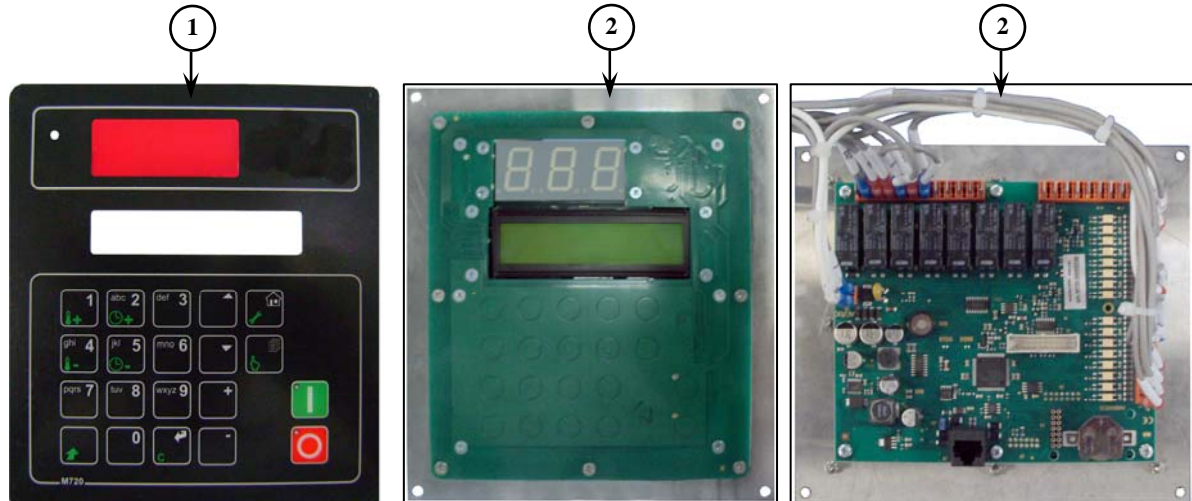

Model : Microprocessor control

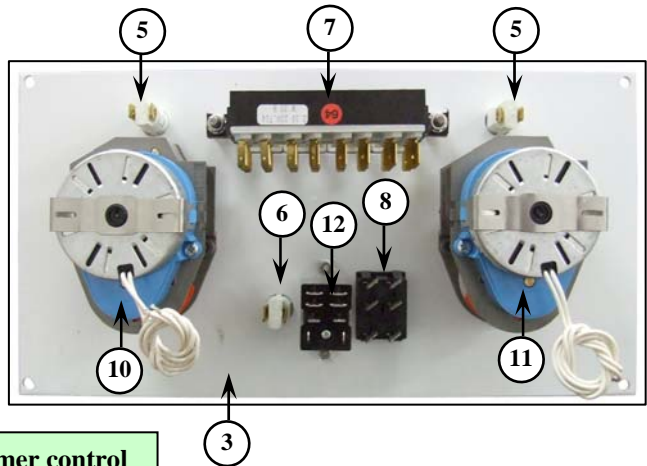
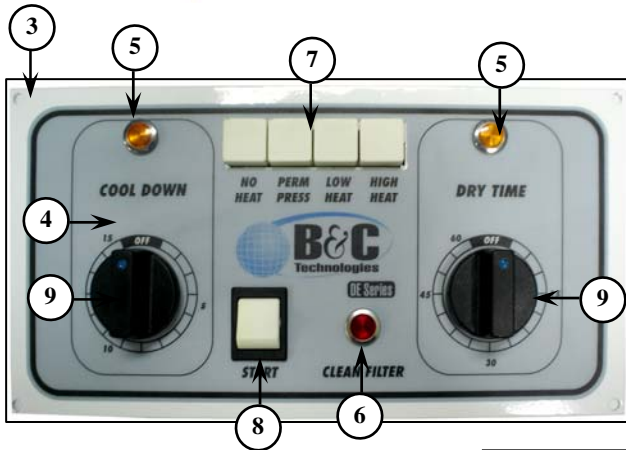
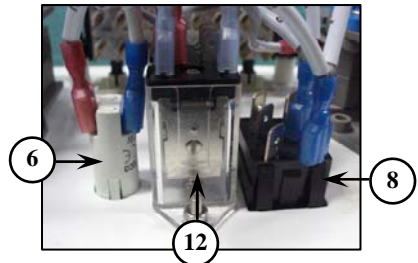

Model : Timer control

Item	Part No.			Qty.	Description
	DE 30	DE 50	DE 75		
1	A0-TSEN01-1465	A0-TSEN01-1465	A0-TSEN01-1465	1	Front plate ( cover )
2	A0-TSEN01-1467	A0-TSEN01-1467	A0-TSEN01-1467	1	Mobics M720 Dryer Controller
3	A2-SDE1-025	A2-SDE1-025	A2-SDE1-025	1	Controller plate (For timer)
4	A0-A090-049	A0-A090-049	A0-A090-049	1	Decal for timer controller
5	A0-E059-006	A0-E059-006	A0-E059-006	2	Indicator lamp (Amber)
6	A0-E059-005	A0-E059-005	A0-E059-005	1	Indicator lamp (Red)
7	A0-E033-011	A0-E033-011	A0-E033-011	1	Selector switch (4 Push button)
8	A0-E033-009	A0-E033-009	A0-E033-009	1	Switch On-Off
9	A0-A086-004	A0-A086-004	A0-A086-004	2	Knob, Pointer control
10	A0-E031-002	A0-E031-002	A0-E031-002	1	Timer controller (60 min)
11	A0-E031-003	A0-E031-003	A0-E031-003	1	Timer controller (15 min)
12	A0-E009-017	A0-E009-017	A0-E009-017	1	Relay
13	A0-TSEN01-1470	A0-TSEN01-1470	A0-TSEN01-1470	1	Sensor Probe cable M703B
14	A0-TSEN01-1471	A0-TSEN01-1471	A0-TSEN01-1471	1	PCB connect Sensor Probe M703A

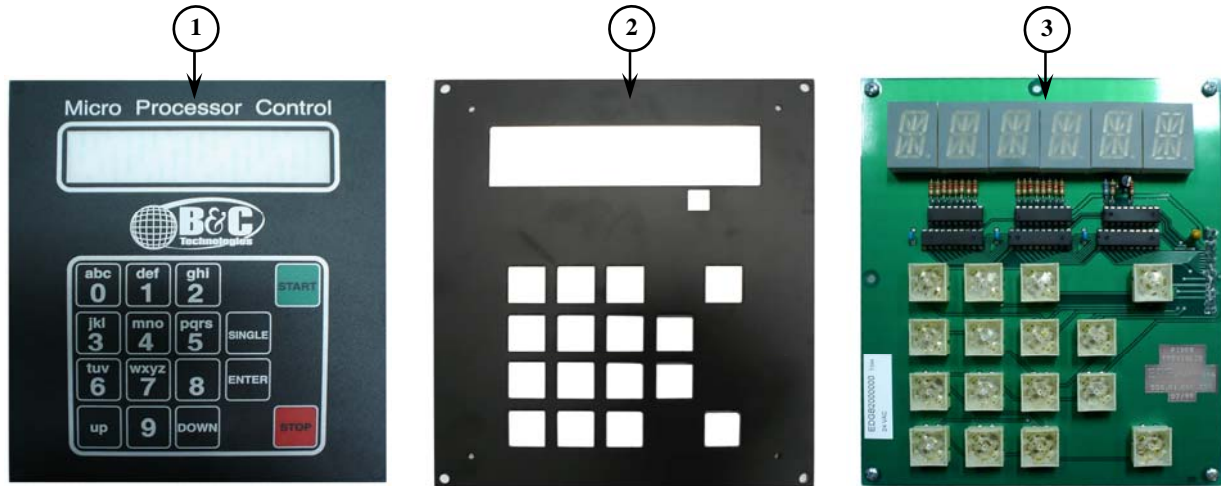

Model : Microprocessor control

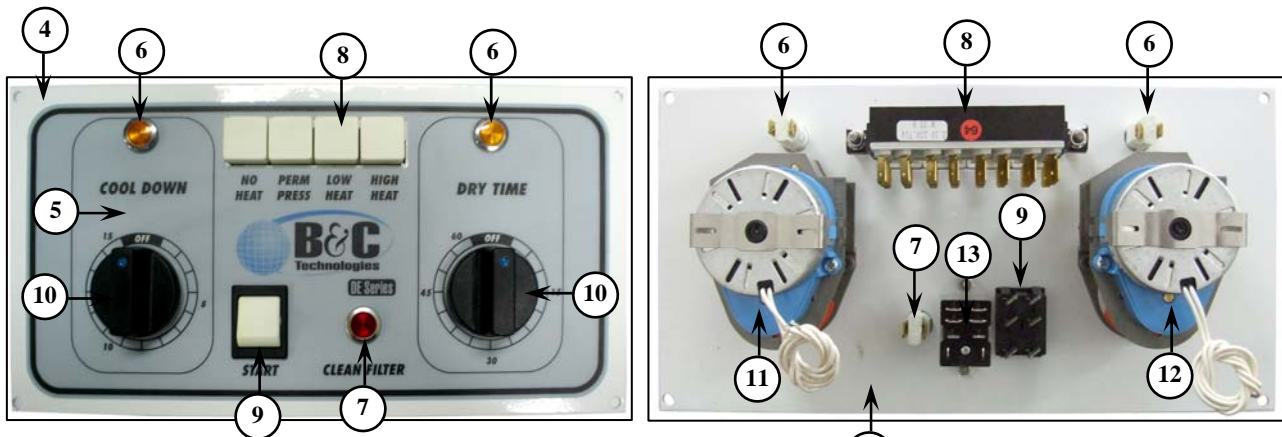

Model : Timer control

Item	Part No.			Qty.	Description
	DE 30	DE 50	DE 75		
1	A0-A090-039	A0-A090-039	A0-A090-039	1	Decal for microprocessor controller (EDG)
2	A2-SDE1-024	A2-SDE1-024	A2-SDE1-024	1	Controller plate (For EDG)
3	A0-E007-004	A0-E007-004	A0-E007-004	1	Microprocessor controller (EDG)
4	A2-SDE1-025	A2-SDE1-025	A2-SDE1-025	1	Controller plate (For timer)
5	A0-A090-049	A0-A090-049	A0-A090-049	1	Decal for timer controller
6	A0-E059-006	A0-E059-006	A0-E059-006	2	Indicator lamp (Amber)
7	A0-E059-005	A0-E059-005	A0-E059-005	1	Indicator lamp (Red)
8	A0-E033-011	A0-E033-011	A0-E033-011	1	Selector switch (4 Push button)
9	A0-E033-009	A0-E033-009	A0-E033-009	1	Switch On-Off
10	A0-A086-004	A0-A086-004	A0-A086-004	2	Knob, Pointer control
11	A0-E031-002	A0-E031-002	A0-E031-002	1	Timer controller (60 min)
12	A0-E031-003	A0-E031-003	A0-E031-003	1	Timer controller (15 min)
13	A0-E009-017	A0-E009-017	A0-E009-017	1	Relay

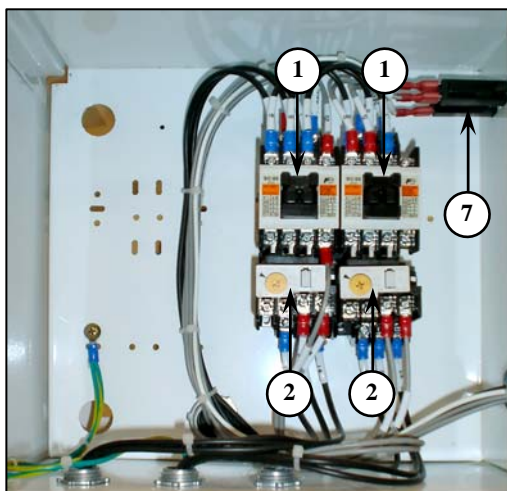

Model : Single Phase 2 Motor

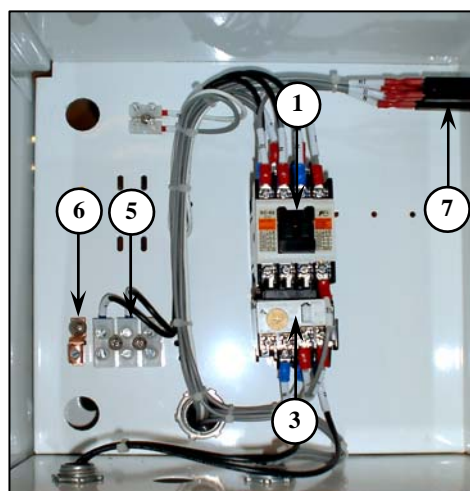

Model : Single Phase 1 Motor

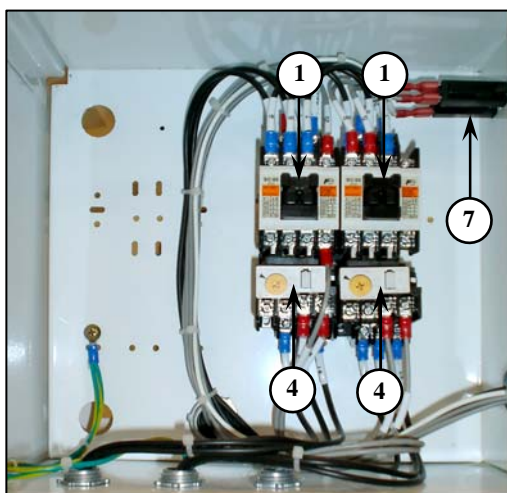

Model : Three Phase 2 Motor

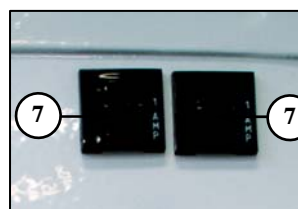

Control Circuit Breaker

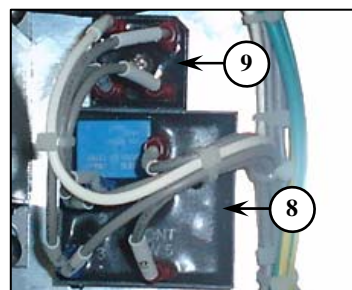

Option : Rotation Sensor

Item	Part No.			Qty.	Description
	DE 30	DE 50	DE 75		
1	A0-E004-065	A0-E004-065	A0-E004-065	1,2	Magnetic contactor
2	A0-E025-054	A0-E025-054	A0-E025-054	2	Overload (200-240V)
3	A0-E025-054	A0-E025-054	A0-E025-054	1	Overload (200-240V)
4	A0-E025-053	A0-E025-053	A0-E025-053	2	Overload (200-240V)
	A0-E025-052	A0-E025-052	A0-E025-052	2	Overload (380-440V)
5	A0-E021-031/1	A0-E021-031/1	A0-E021-031/1	1	Terminal block
6	A0-E055-001	A0-E055-001	A0-E055-001	1	Connector, Ground lug
7	A0-E010-031	A0-E010-031	A0-E010-031	2	Circuit breaker 1A
8	A0-E031-019	A0-E031-019	A0-E031-019	1	Watch dog timer
9	A0-E050-002	A0-E050-002	A0-E050-002	1	Bridge Rectifier

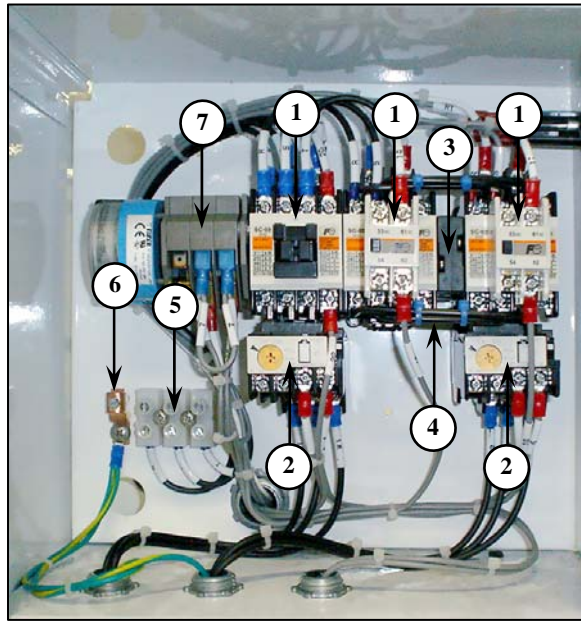

Magnetic contactor

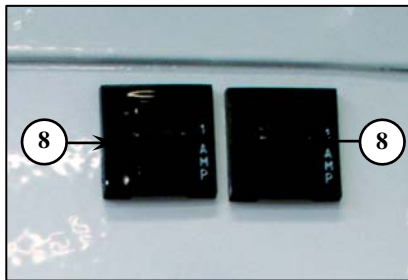

Control Circuit Breaker

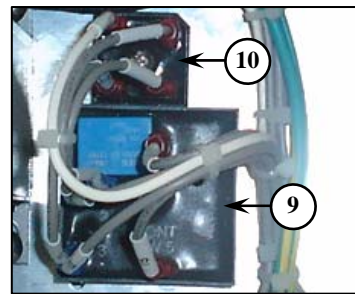

Option : Rotation Sensor

Item	Part No.			Qty.	Description
	DE 30	DE 50	DE 75		
1	A0-E004-065	A0-E004-065	A0-E004-065	3	Magnetic contactor
	A0-E024-011	A0-E024-011	A0-E024-011	2	Auxiliary contact
2	A0-E025-053	A0-E025-053	A0-E025-053	2	Overload (200-240V)
	A0-E025-052	A0-E025-052	A0-E025-052	2	Overload (380-440V)
3	A0-E036-006	A0-E036-006	A0-E036-006	1	Mechanical interlock
4	A0-E036-007	A0-E036-007	A0-E036-007	2	Power connection kit for reversing
5	A0-E021-031/1	A0-E021-031/1	A0-E021-031/1	1	Terminal block
6	A0-E055-001	A0-E055-001	A0-E055-001	1	Connector, Ground lug
7	A0-E017-002	A0-E017-002	A0-E017-002	1	Timer reversing (For Timer Model)
8	A0-E010-031	A0-E010-031	A0-E010-031	2	Circuit breaker 1A
9	A0-E031-019	A0-E031-019	A0-E031-019	1	Watch dog timer
10	A0-E050-002	A0-E050-002	A0-E050-002	1	Bridge Rectifier

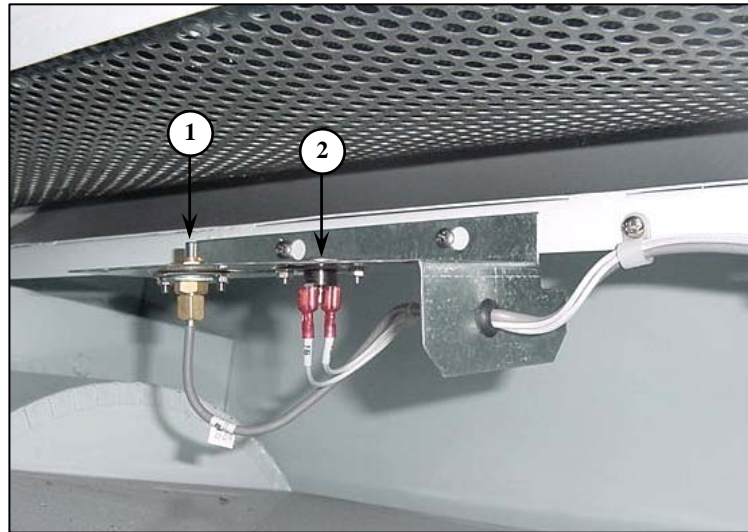

Model : Microprocessor control

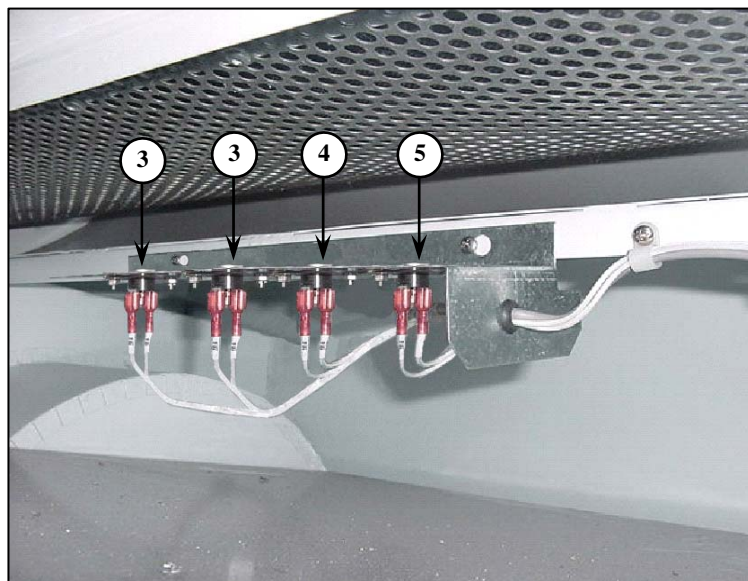

Model : Timer control

Item	Part No.			Qty.	Description
	DE 30	DE 50	DE 75		
1	A0-E027-010	A0-E027-010	A0-E027-010	1	Temperature probe
2	A0-E016-011	A0-E016-011	A0-E016-011	1	Thermostat for high temp
3	A0-E016-011	A0-E016-011	A0-E016-011	2	Thermostat for "High Hear" selector
4	A0-E016-003	A0-E016-003	A0-E016-003	1	Thermostat for "Low Heat" selector
5	A0-E016-005	A0-E016-005	A0-E016-005	1	Thermostat for "Perm Press" selector

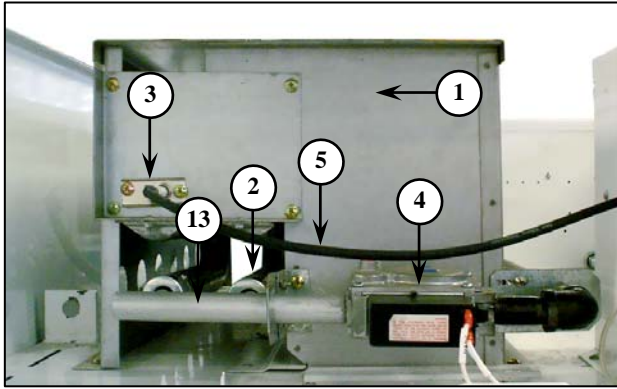

Model : 30 lb.

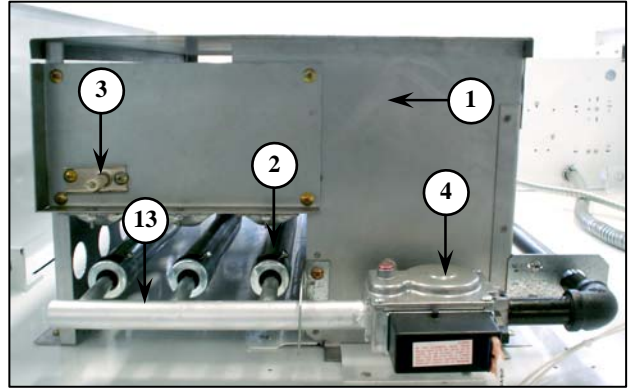

Model : 50 lb.

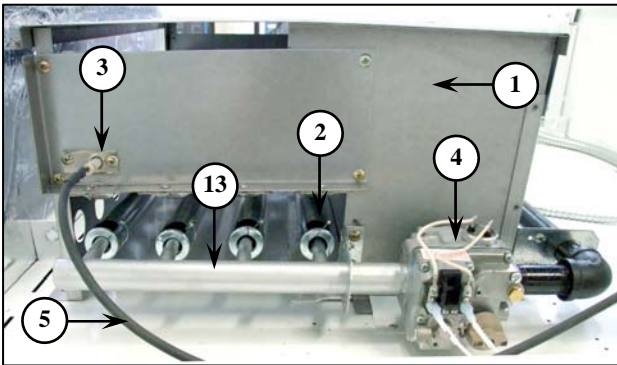

Model : 75 lb.

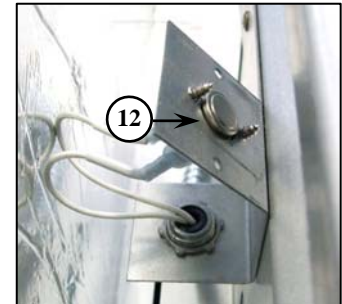
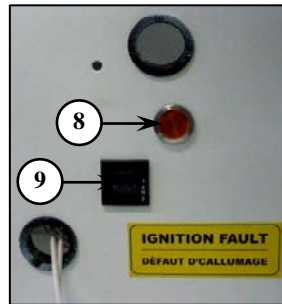
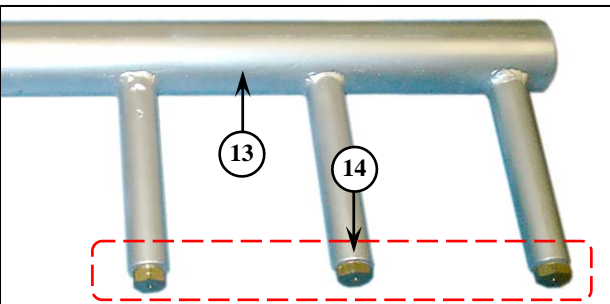
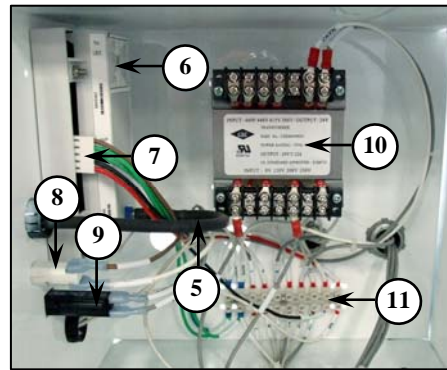

Item	Part No.			Qty.	Description
	DE 30	DE 50	DE 75		
1	A0-A027-001	A0-A027-002	A0-A027-003	1	Gas burner
2	A0-A089-001	A0-A089-001	A0-A089-001	2,3,4	Gas burner tube
3	A0-E019-005	A0-E019-005	A0-E019-005	1	Spark probe
4	A0-E018-001	A0-E018-001	A0-E018-009	1	Gas valve (LP Gas)
	A0-E018-001	A0-E018-009	A0-E018-009	1	Gas valve (Natural Gas)
5	A0-E019-006	A0-E019-006	A0-E019-006	1	Wire, Suppression
6	A0-E020-001	A0-E020-001	A0-E020-001	1	Ignition control
7	A0-E020-202	A0-E020-202	A0-E020-202	1	Wiring harnesses
8	A0-E059-005	A0-E059-005	A0-E059-005	1	Indicator lamp (Red)
9	A0-E010-034	A0-E010-034	A0-E010-034	1	Circuit breaker 3A
10	A0-E006-029	A0-E006-029	A0-E006-029	1	Transformer 75VA
11	A0-E021-039	A0-E021-039	A0-E021-039	1	Terminal block
12	A0-E016-013	A0-E016-013	A0-E016-013	1	Thermostat for high limit
13	A2-S030-039	A2-S050-039	A2-S075-039	1	Gas manifold
14	A0-A105-001-01	A0-A105-001-01	A0-A105-001-01	2,3,4	Nozzles gas LP Gas brass 1/8" Hole 2mm.
	A0-A105-001-02	A0-A105-001-02	A0-A105-001-02	2,3,4	Nozzles gas NGas brass 1/8" Hole 3mm.

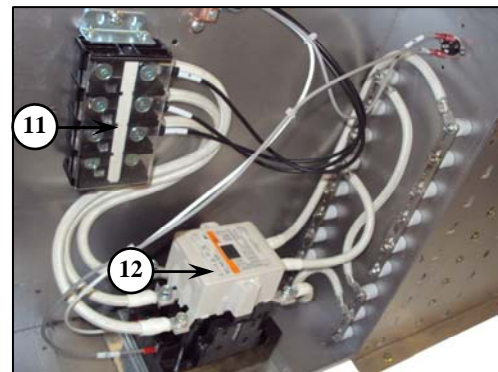
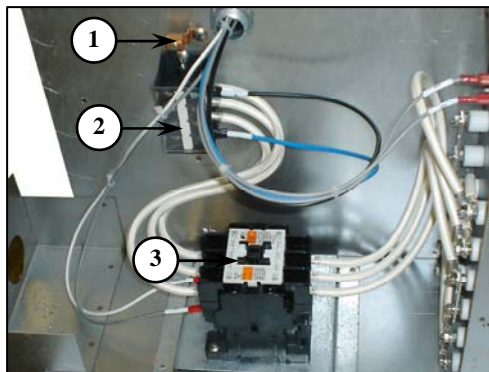
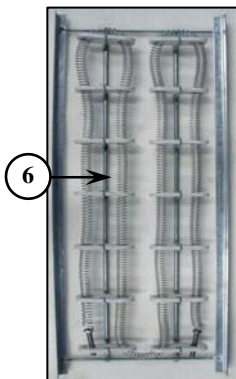
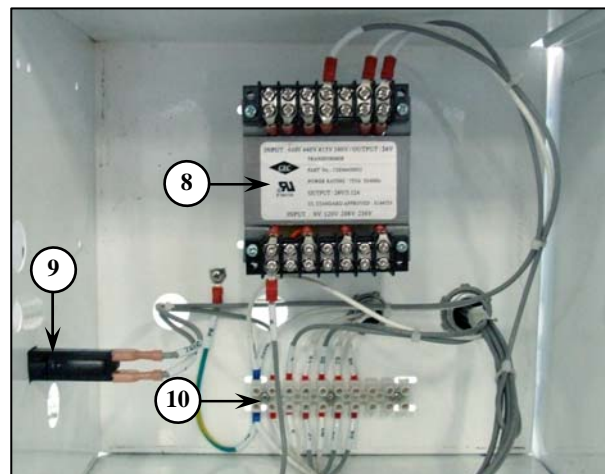
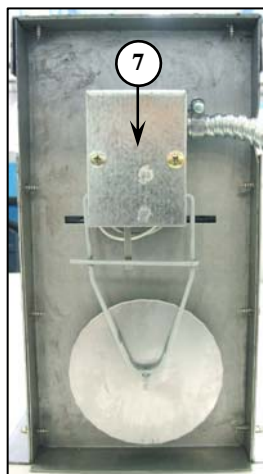
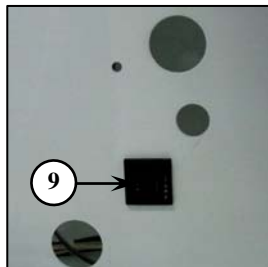
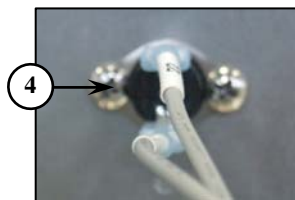
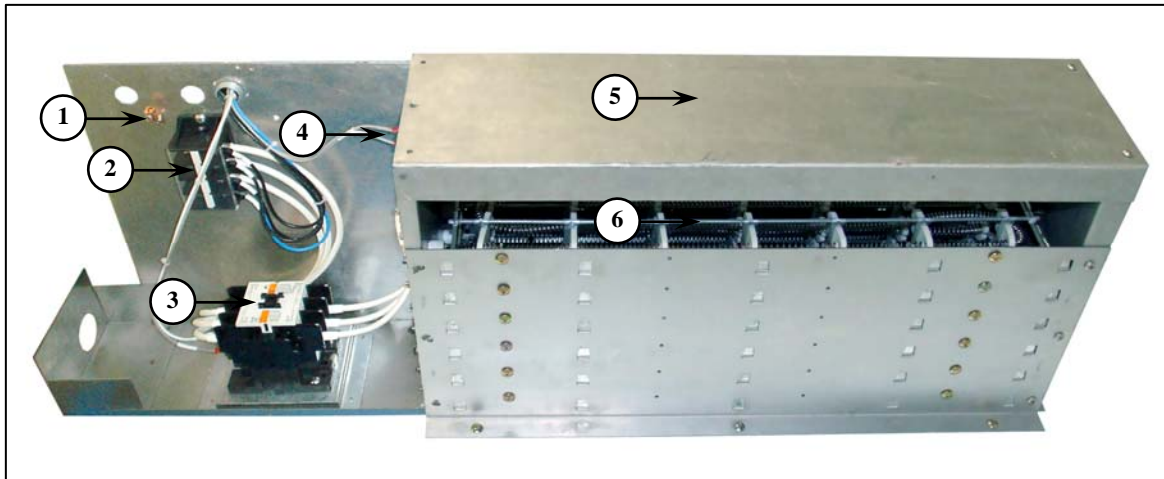

Item	Part No.			Qty.	Description
	DE 30	DE 50	DE 75		
1	A0-E055-001	A0-E055-001	A0-E055-001	1	Connector, Ground lug
2	A0-E021-031/1	A0-E021-031/1	A0-E021-031/1	1	Terminal block
3	A0-E004-072	A0-E004-072	A0-E004-076	1	Magnetic contactor for heater
4	A0-E016-013	A0-E016-013	A0-E016-013	1	Thermostat for high limit
5	A0-E013-004	A0-E013-004	A0-E013-005	1	Electric heater (Complete set)
6	A0-E005-009	A0-E005-009	A0-E005-009	6,9	Electric heater (Heater coil)
7	A0-E014-014	A0-E014-014	A0-E014-014	1	Micro switch
8	A0-E006-029	A0-E006-029	A0-E006-029	1	Transformer 75VA
9	A0-E010-034	A0-E010-034	A0-E010-034	1	Circuit breaker 3A
10	A0-E021-039	A0-E021-039	A0-E021-039	1	Terminal block
11	-	-	A0-E021-142	1	Terminal block (Option)
12	-	-	A0-E004-078	1	Magnetic Contactor "FUJI" (Option)

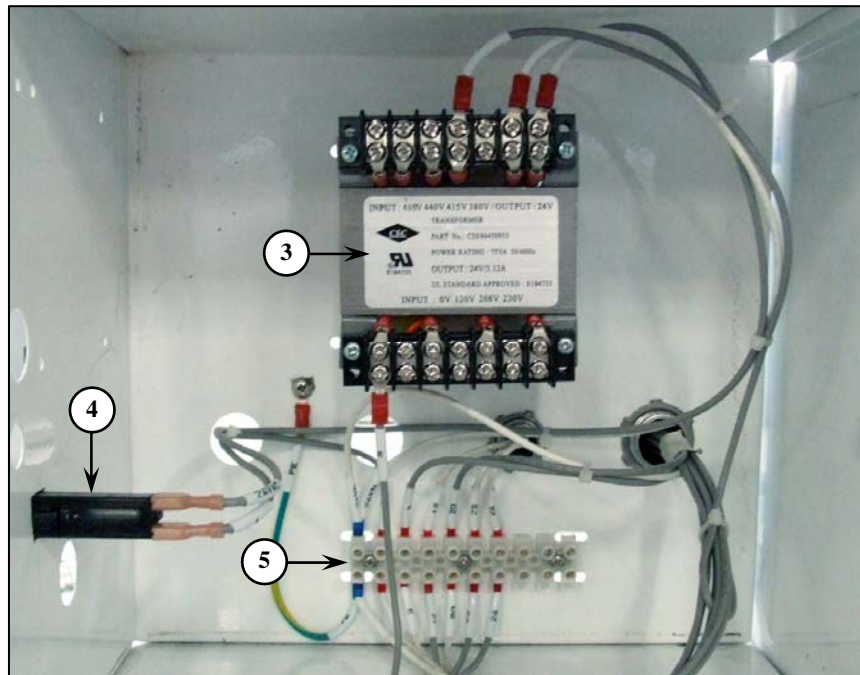
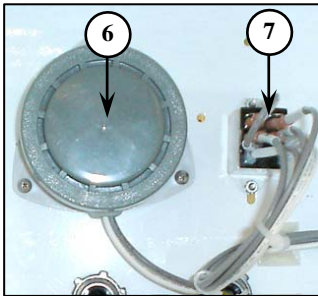
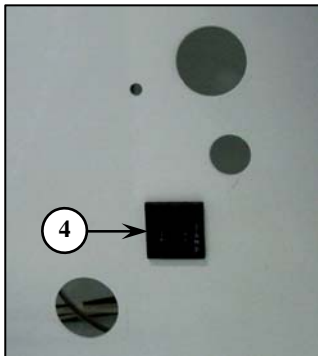
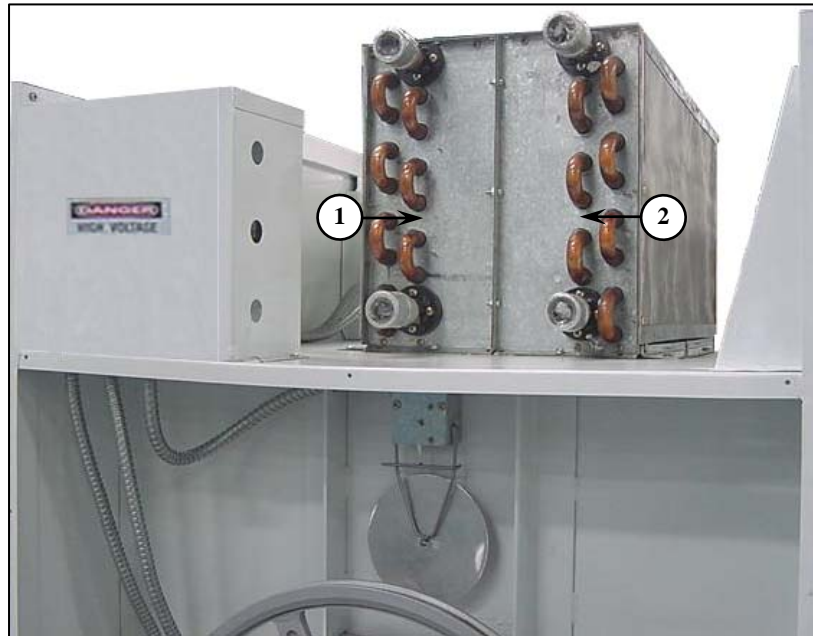

Item	Part No.			Qty.	Description
	DE 30	DE 50	DE 75		
1	A0-A026-001	A0-A026-002	A0-A026-002	1	Steam coil (Left)
2	A0-A026-010	A0-A026-011	A0-A026-011	1	Steam coil (Right)
3	A0-E006-029	A0-E006-029	A0-E006-029	1	Transformer 75VA
4	A0-E010-034	A0-E010-034	A0-E010-034	1	Circuit breaker 3A
5	A0-E021-039	A0-E021-039	A0-E021-039	1	Terminal block
6	A0-E042-002	A0-E042-002	A0-E042-002	1	Buzzer (Optional)
7	A0-E009-017	A0-E009-017	A0-E009-017	1	Relay (Optional)



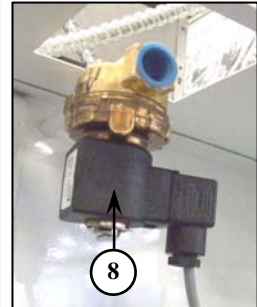
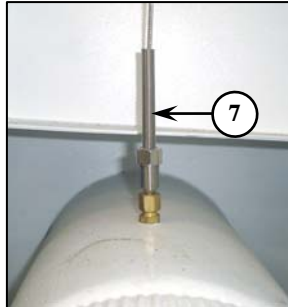
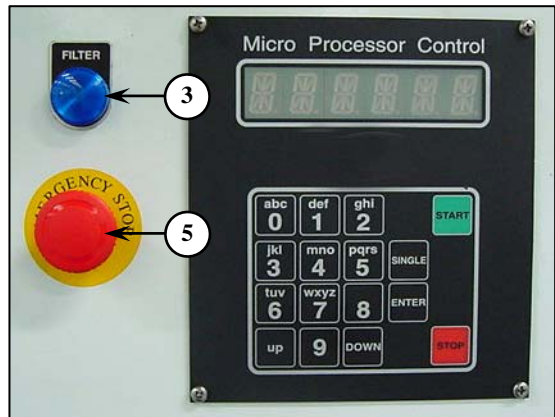
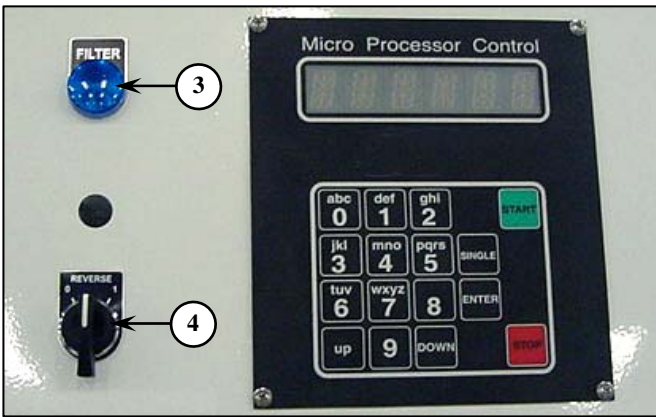
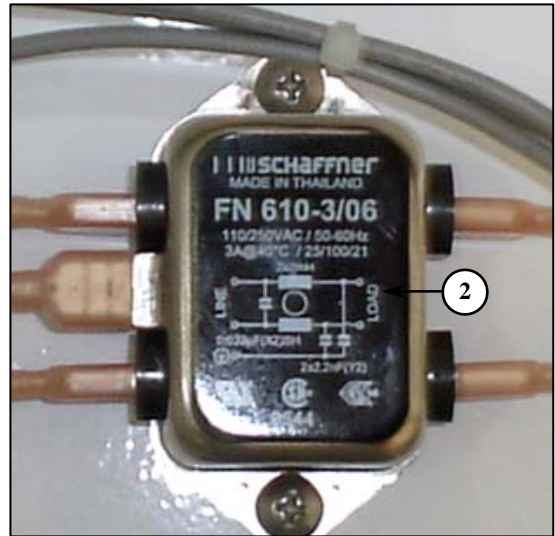
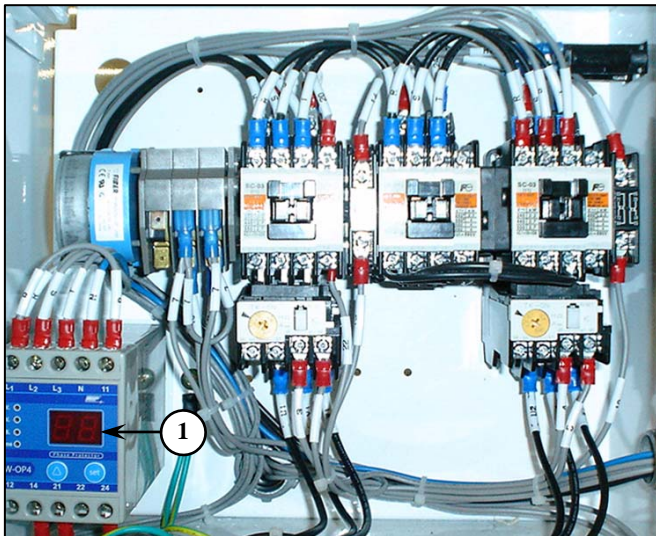

Item	Part No.			Qty.	Description
	DE 30	DE 50	DE 75		
1	A0-E010-024	A0-E010-024	A0-E010-024	1	Phase protection
2	A0-E003-014	A0-E003-014	A0-E003-014	1	EMI Filter
3	A0-E035-021	A0-E035-021	A0-E035-021	1	Lamp indicator
4	A0-E033-003	A0-E033-003	A0-E033-003	1	Selector switch
5	A0-E032-018	A0-E032-018	A0-E032-018	1	Emergency stop
6	A0-E027-002	A0-E027-002	A0-E027-002	1	Temperature controller
7	A0-E027-033	A0-E027-033	A0-E027-033	1	Temperature sensor
8	A0-E040-001	A0-E040-001	A0-E040-001	1	Sprinkler valve